

Infinity *Reference 1250w 12" Woofer – Technical Data*

CAR AUDIO

SPECIFICATIONS

DIAMETER:	12" (300mm)
SENSITIVITY (2.83 V @ 1 m):	93 dB
POWER HANDLING:	300 W _{RMS} 1200 W _{PEAK}
FREQUENCY RESPONSE:	23 ~ 400 Hz
NOMINAL IMPEDANCE:	4 OHMS
VOICE-COIL DIAMETER:	2.0" (51.0 mm)

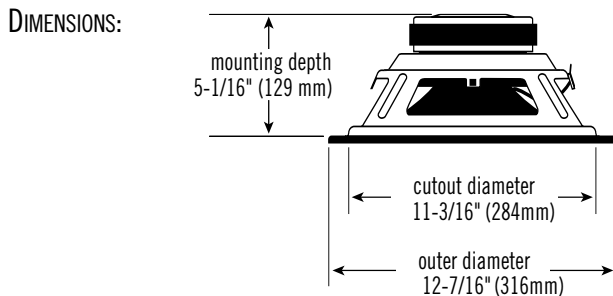

THIELE-SMALL PARAMETERS

VOICE COIL DC RESISTANCE:	R_{EVC} (OHMS)	3.40
VOICE COIL INDUCTANCE @ 1 kHz:	L_{EVC} (MH)	2.54
DRIVER RADIATING AREA:	S_D (IN ²)	82.46
	S_D (M ²)	532.00
MOTOR FORCE FACTOR:	BL (TM)	14.24
COMPLIANCE VOLUME:	V_{AS} (FT ³)	3.00
	V_{AS} (LITERS)	84.40
SUSPENSION COMPLIANCE:	C_{MS} (μM/N)	210.00
MOVING MASS, AIR LOAD:	M_{MS} (GRAMS)	187.60
MOVING MASS, DIAPHRAGM:	M_{MD} (GRAMS)	180.60
FREE-AIR RESONANCE:	F_S (Hz)	25.40
MECHANICAL Q:	Q_{MS}	7.62
ELECTRICAL Q:	Q_{ES}	0.50
TOTAL Q:	Q_{TS}	0.47
MAGNETIC-GAP HEIGHT:	H_{AG} (IN)	3/8
	H_{AG} (MM)	9.00
VOICE-COIL HEIGHT:	H_{VC} (IN)	1-1/4
	H_{VC} (MM)	32
MAXIMUM EXCURSION:	X_{MAX} (IN)	7/16
	X_{MAX} (MM)	11.50

SEALED BOX VOLUME (INCLUDES DRIVER DISPLACEMENT)

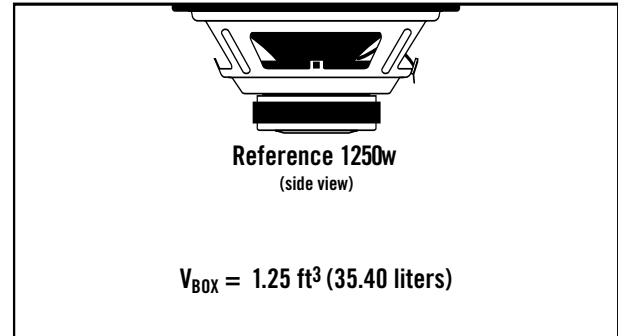

SEALED ENCLOSURE FREQUENCY RESPONSE @ 2.83 V

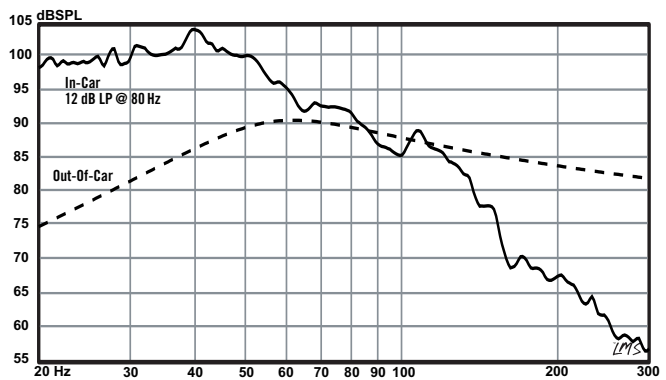

SEALED ENCLOSURE CONE EXCURSION @ 300 W

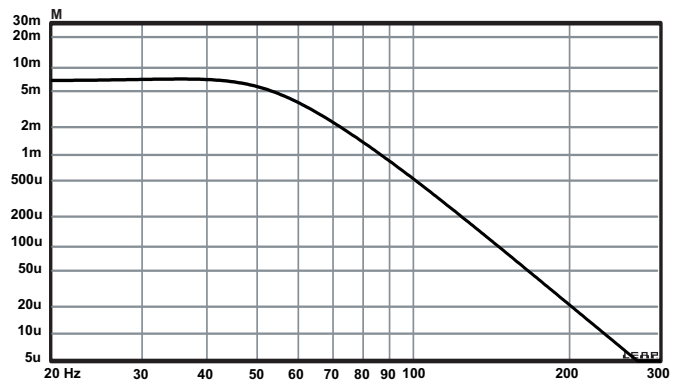

Infinity *Reference 1250w 12" Woofer – Technical Data*

CAR AUDIO

VENTED BOX VOLUME (INCLUDES DRIVER/PORT DISPLACEMENTS)

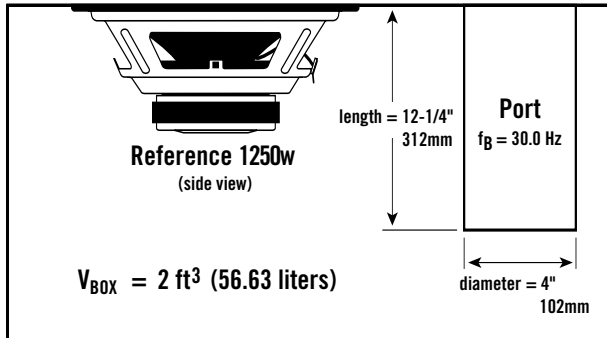

BANDPASS BOX VOLUME (INCLUDES DRIVER/PORT DISPLACEMENTS)

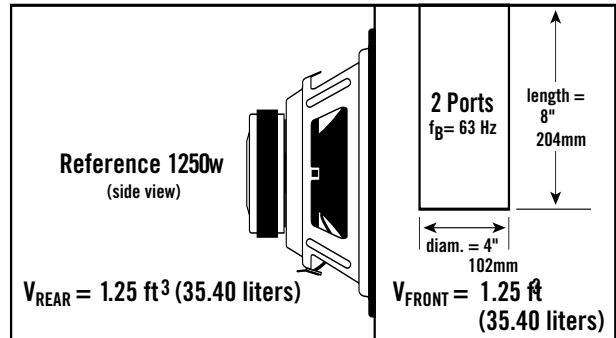

VENTED ENCLOSURE FREQUENCY RESPONSE @ 2.83 V

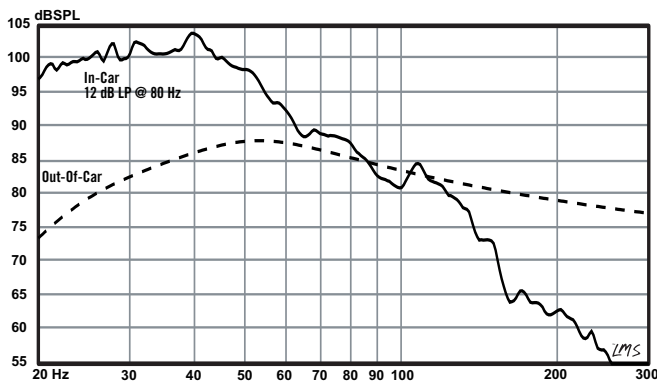

BANDPASS ENCLOSURE FREQUENCY RESPONSE @ 2.83 V

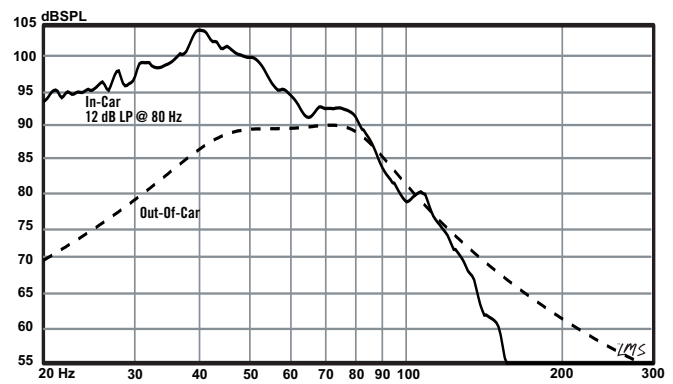

VENTED ENCLOSURE CONE EXCURSION @ 300 W

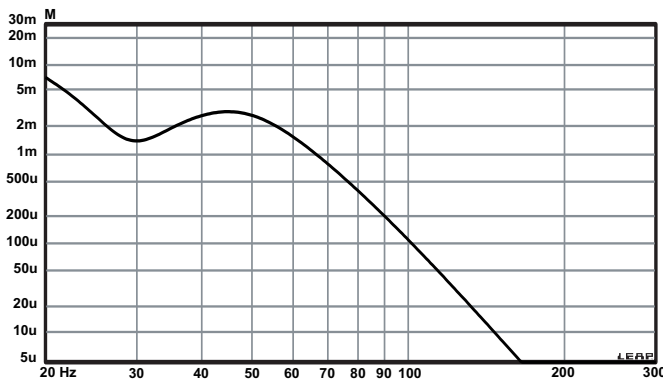

BANDPASS ENCLOSURE CONE EXCURSION @ 300 W

